

1. predsieň TINA 2

Montážny návod







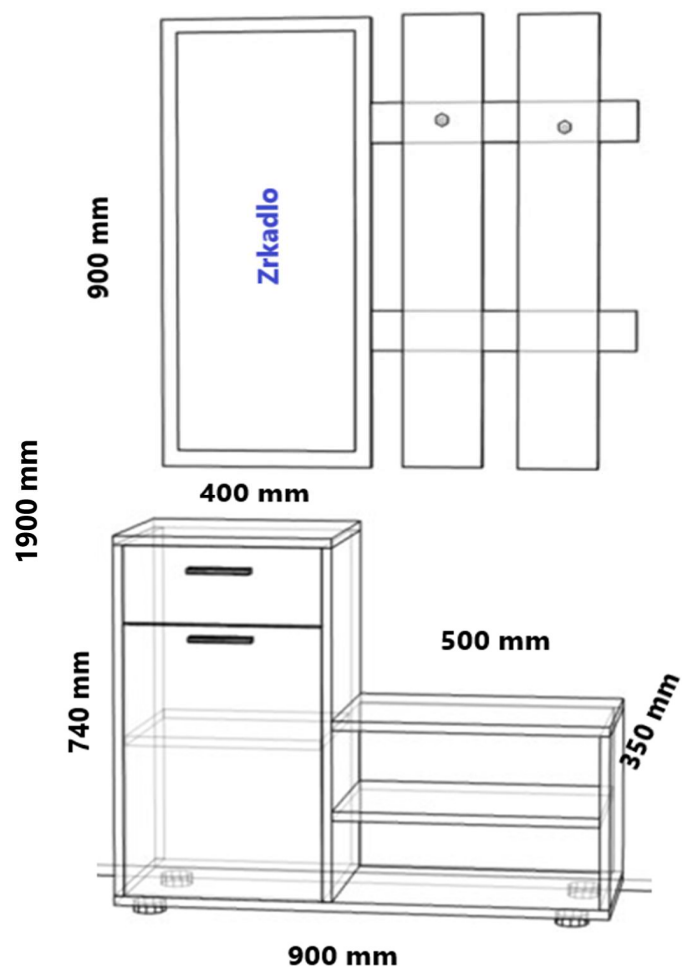







Montážní návod

Die Montage Anleitung

Assembly Instruction



2.

I		5 x	Q		(3,5 x 16mm) 30 x
Z		1 x	R		(3,5 x 30mm) 22 x
M.4		(Vložený) 2 x	U.3		(4 x 50mm) 11 x
		(Vešiak) 2 x	F		40 x
		(Uchytka) 2 x	H		8 x
		(300 mm) 1 pár	A		42 x
		2x	J		2x

3.

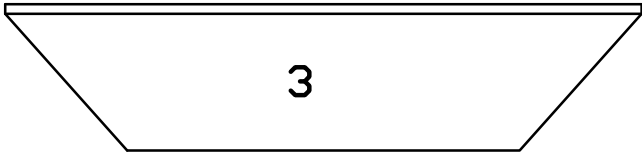

Na jskôr zmontuj 2-1 + 3-1 + 2 + 5-1
Nejdřív smontuj 2-1 + 3-1 + 2 + 5-1
First together 2-1 + 3-1 + 2 + 5-1
Zuerst zusammen 2-1 + 3-1 + 2 + 5-1

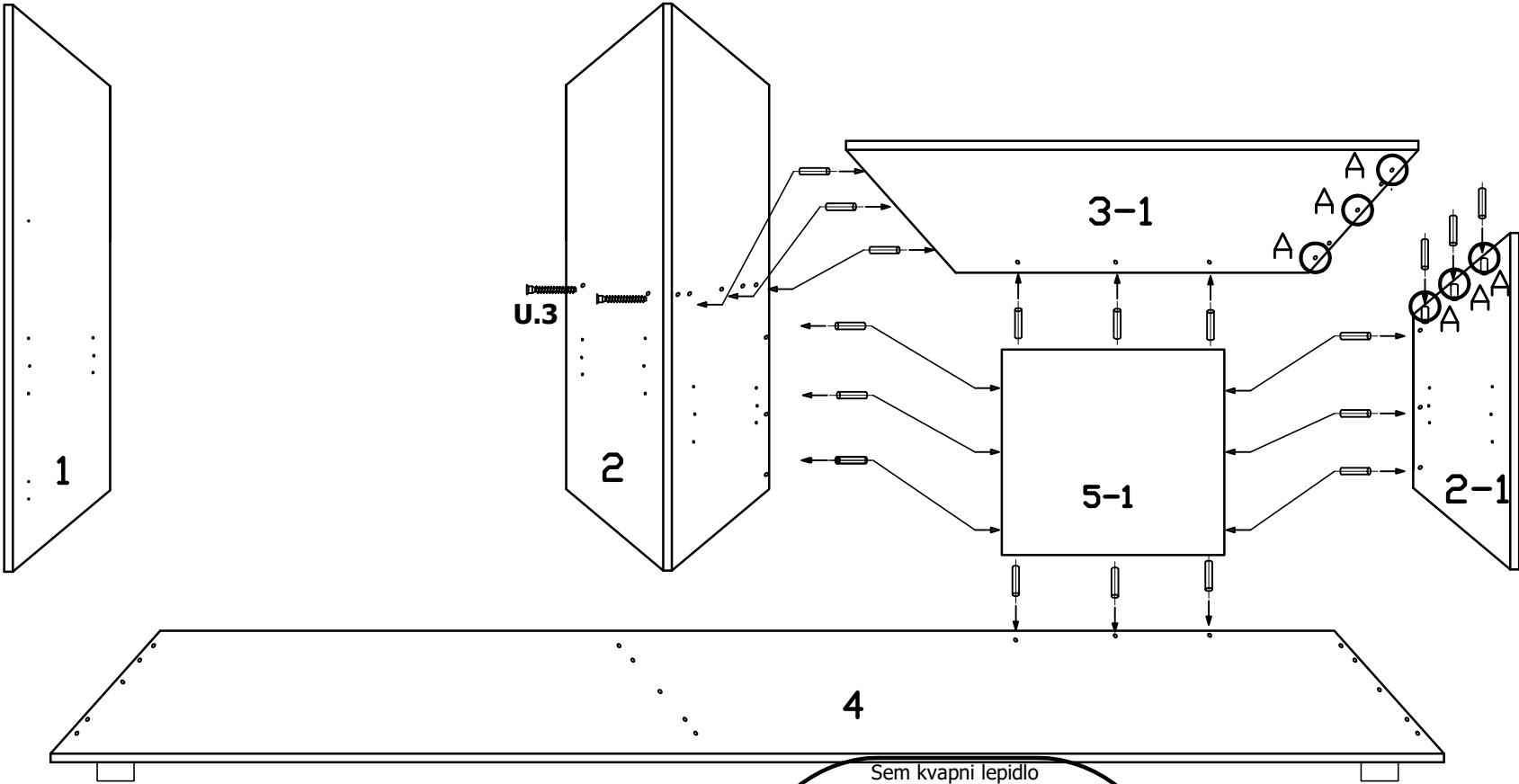

A-Hole for Glue
A-Das Loch fur Kleber
A-Díra pro lepidlo
A-Diera pre lepidlo

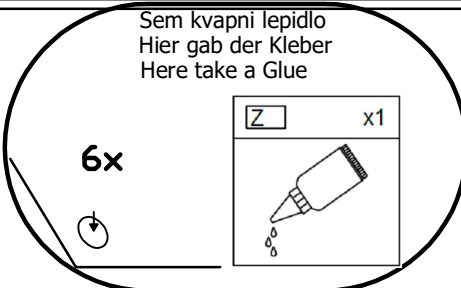

4.

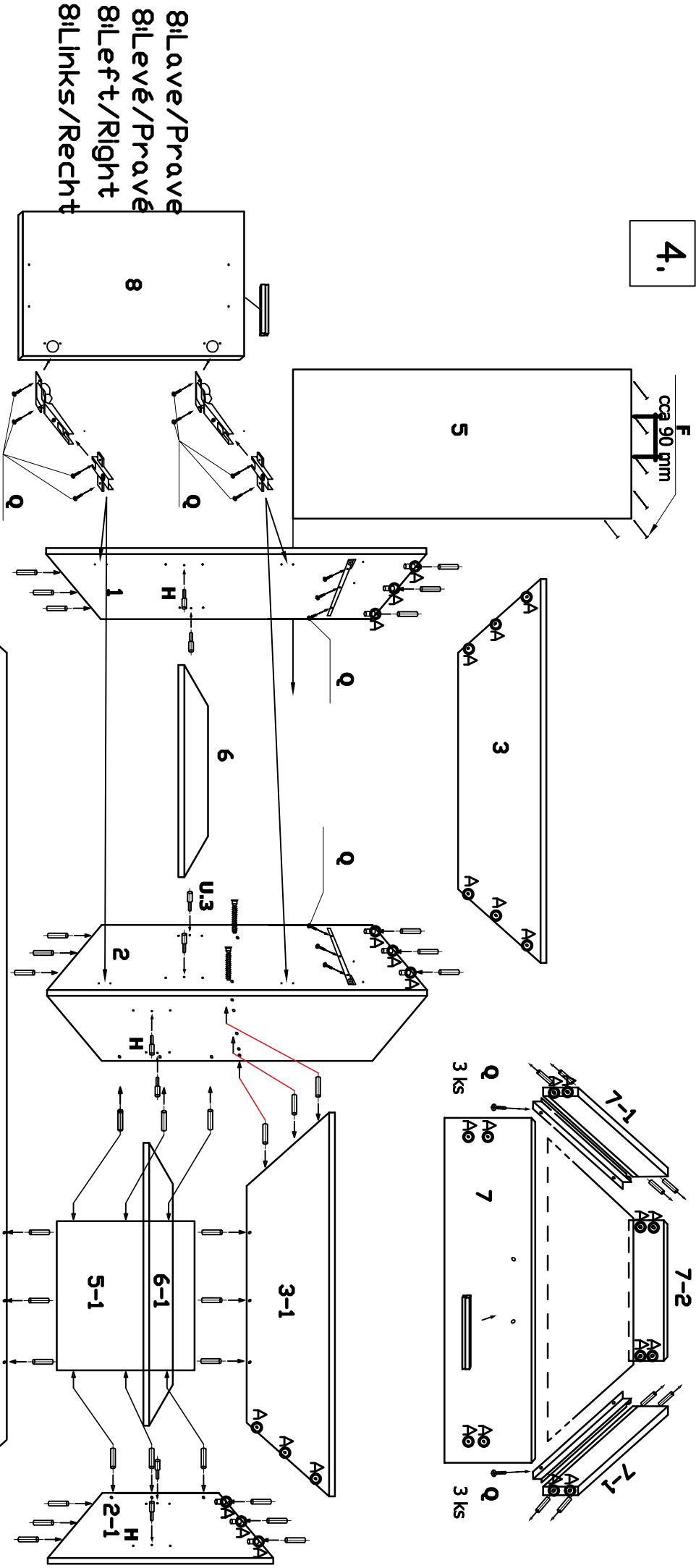

8: Lave/Prave
 8: Levé/Pravé
 8: Left/Right
 8: Links/Rechts

Die Centrum T in Ecke 40 a 40 mm,
 Sřřed T v rohu 40 a 40 mm,
 Střed T v rohu 40 a 40 mm,

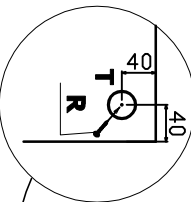

A-Hole for Glue
 A-Das Loch für Kleber
 A-Díra pro lepidlo
 A-Diera pre lepidlo

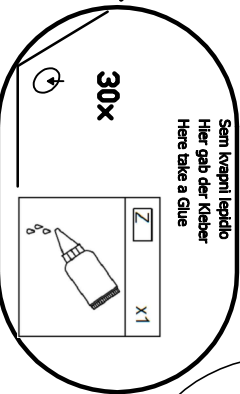

Sam kvapni lepidlo
 Hier gib der Kleber
 Here take a glue

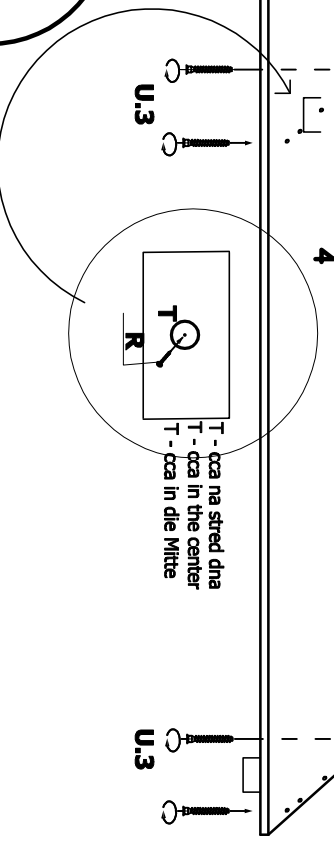

T - cca na střed dna
 T - cca in the center
 T - cca in die Mitte

5,

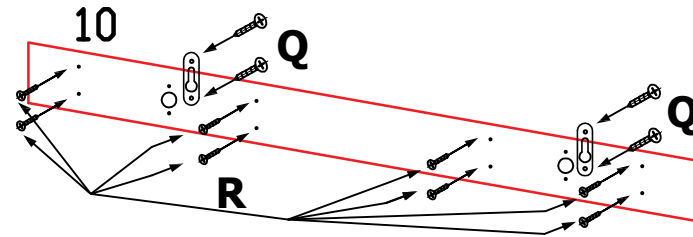

Montuj zo zadnej plochy

Montuj ze zad

Montiert aus Hinterseite

Assemble from Backside

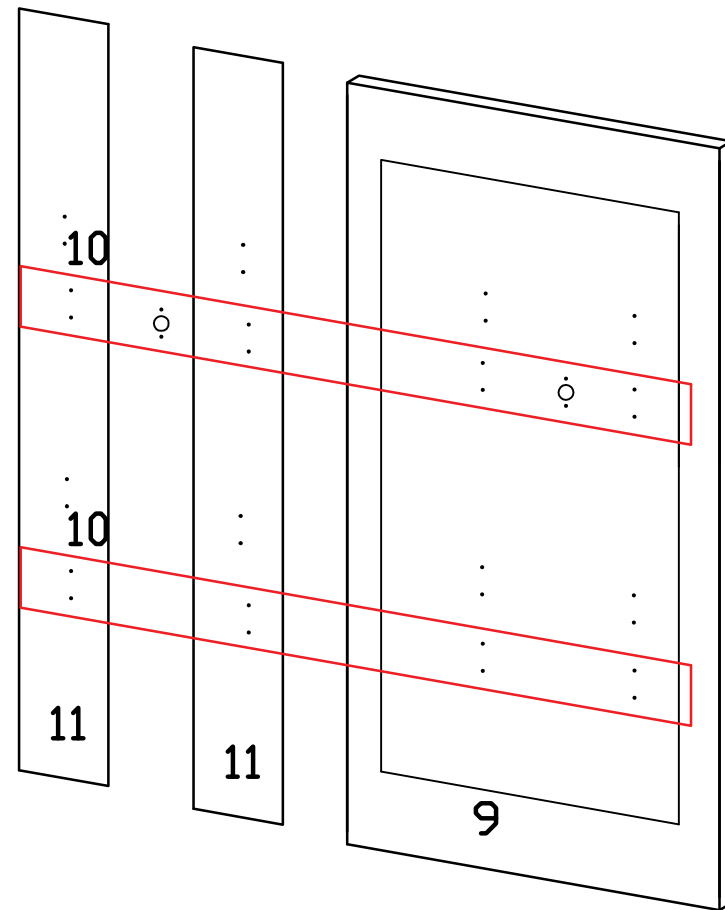

6,

Pohlad - predok

Pohled - předeek

Look - frontside

Sehnen - Der Vorher

